

TIRE DEALERS

Maximize Uptime With The Industry's Most Durable Products

1600-3D DIRECT DRIVE WHEEL BALANCER

Legendary reliability
with state of the art
capability.



Powered by Direct Drive



The motor and spindle are combined into a single, pre-balanced assembly that always stays calibrated to zero.

ProBalance Technology®

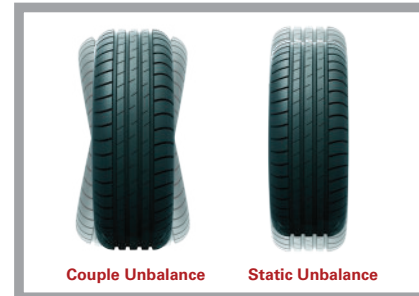

A unique balancing system (unbalance correction methodology) that minimizes both static and couple unbalance

SpeedThread™



Provides the ability to thread the hub nut at the push of a pedal to improve the ease-of-use and speed of mounting the wheel

To learn more about the Coats 1600-3D Wheel Balancer, or any of our other quality products, contact your authorized Coats distributor or call **1-855-876-3864** for the dealer nearest you.

COATS®

CONTACT US NOW

www.coatsgarage.com
or call 1-855-876-3864



1600-3D DIRECT DRIVE WHEEL BALANCER

1600-3D DIRECT DRIVE WHEEL BALANCER

LEGENDARY RELIABILITY WITH STATE OF THE ART CAPABILITY.

SPECIFICATIONS

Balancing Modes	8
Wheel Diameter Range	8" - 30"
Wheel Width Range	2" - 20"
Maximum Tire Diameter	Up to 44"
Maximum Tire Weight	160 lbs.
Shaft Diameter	40 mm
Footprint	57"w x 55"d x 75"h
Ship Weight	650 lbs.
Interface	Touchscreen
Automatic Data Entry	Distance/Diameter/Width
Electrical Requirements	220v, 1ph or 220v, 3ph
Warranty	3Year Parts, 6 Months Labor
Part Number	80016003D - 1ph 80016003D01 - 3ph

EQUIPMENT FOOTPRINT

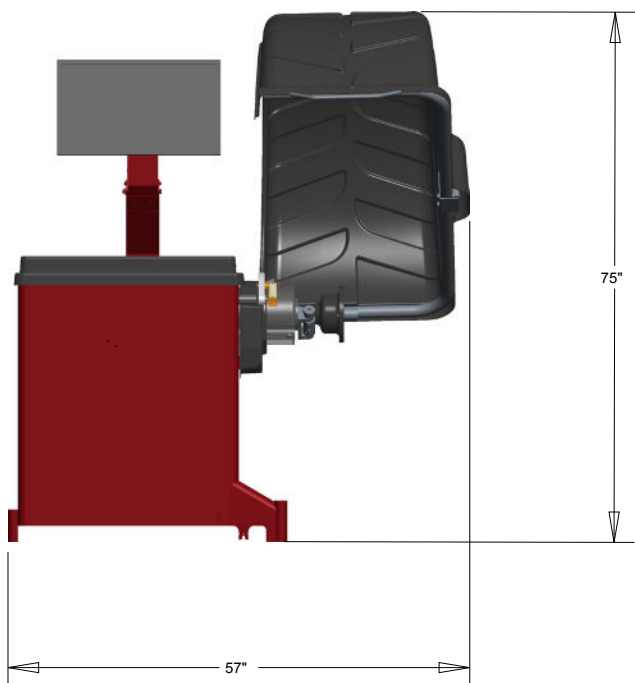

CLASS 2 LASER PRODUCT
LASER LIGHT - DO NOT STARE INTO THE BEAM
635nm - 660nm < 1mW CW



ACCESSORIES

* Included with Purchase

Part Number	Description
*85608850	Stud - Weight Tray (3)
*85609499	Double Sided Collets (2.04"-5.20")
*8309011	Calipers
*85607780	Premium Wheel Weight Hammer
*85610908	Premium Hub Nut
*8112106	Small Pressure Cup & Rubber Lip
*85608312	No Mar Ring
*8112107	Spring
*8113390	Scraper
*85610715	Side Shadow Board

RECOMMENDED OPTIONAL ACCESSORIES



Adjustable Pin Plates
(PN 85610104)



Ford ULA
3 Degree Cone
(PN 81141821)



Light Truck Cone Kit
(PN 8113277C)



Toyota Adapter Kit
(PN 85009945)



Short Cone
(PN 8112421)



Double Sided
Mazda Collet
(PN 85611072)

